

gx & FX
SERIES

SELF-PROPELLED
IRRIGATION
MACHINES

RM
IRRIGATION EQUIPMENT



OUR MISSION

Nowadays, RM is one of the most important companies worldwide committed to manufacturing irrigation equipment, exporting in more than 40 Countries in the world.

Since 1952 – the year when the two founders Mr Augusto Ramenzoni and Mr Bruno Mordonini started their small artisan firm in the province of Parma – the production, development and innovation have always been directed to machines and equipment aimed at improving the quality of life in farming. With more than 60 years' experience, this has allowed us to specialise in irrigation machines and equipment whilst keeping the values of its founders. Those being; honesty, reliability and the development of a strong and enduring working relationship with our customers.

We aim to maintain our reputation as a strong, reliable partner in irrigation through versatile, efficient and user-friendly machines offering the best costs/benefits ratio.



The trademark of 1952





OUR STRENGTH

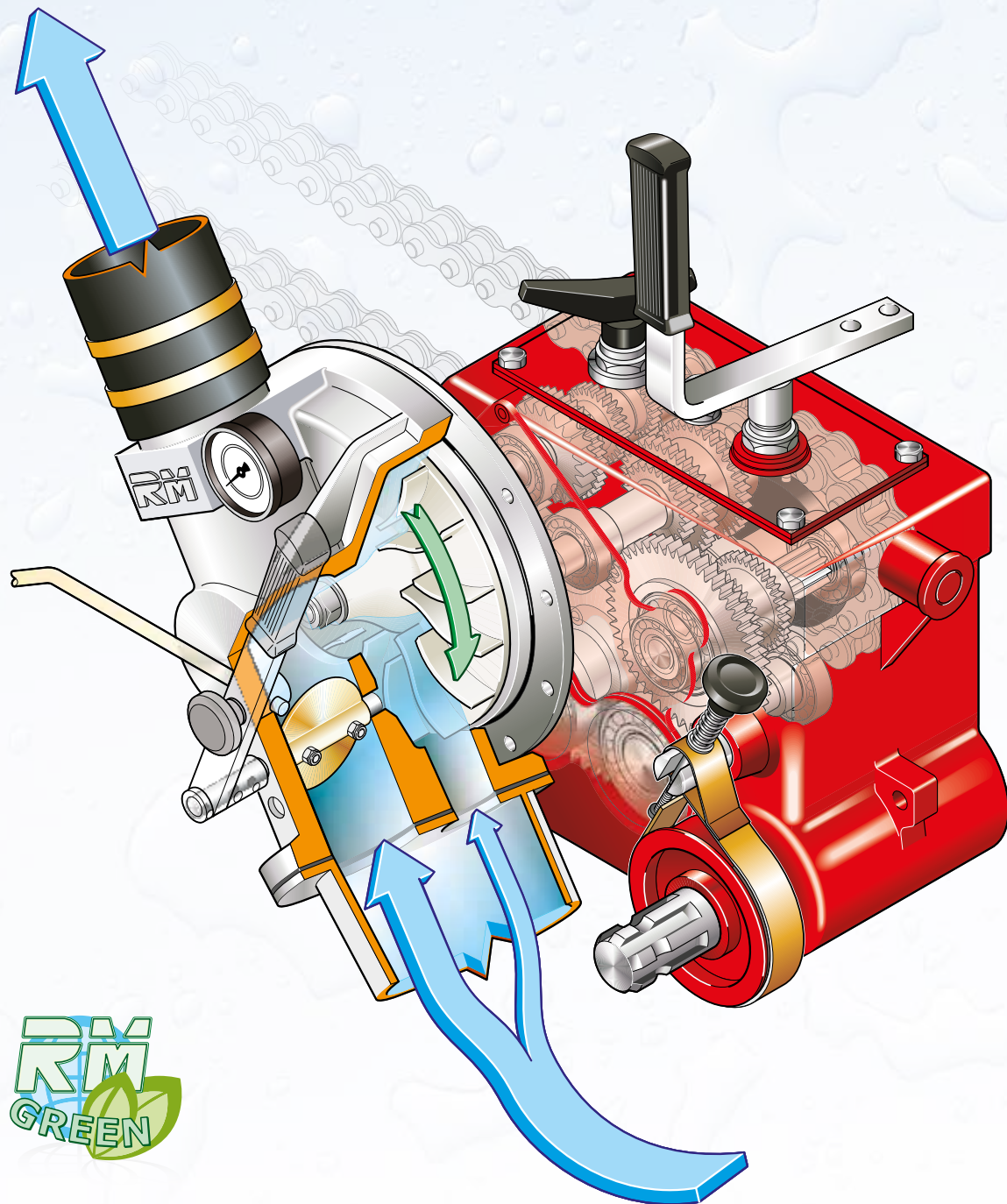

ENERGY EFFICIENCY WITH CONSUMPTION REDUCTION thanks to RM Turbo-Reducers

The energy required to rewind the hose is the decisive element in the economy of the self-propelled irrigation machines: RM Turbo-Reducer Unit with in-built water By-Pass and four-speed gearbox drastically reduces pressure losses during the irrigation phase, thus ensuring money saving determined by less energy consumption.

The design of the turbine impeller is the result of a cutting edge aerodynamic calculation which allowed reaching an extraordinary channelled flow of the liquid without any turbulence, thus ensuring the operation with a minimum pressure of 1.5 bar at machine inlet. The quality of the Turbo-Reducer Unit is obtained by using all the movable internal parts in stainless steel, such as all bearings (including the ones of the turbine axle) in class A dipped in oil bath.

The system includes a built-in automatic brake that engages during hose unwinding and disengages during rewinding. Moreover, at the end of rewind the Turbo-Reducer positions the "Operation-Stop" lever to the correct position for the following hose unwind. The exclusive RM Power Save™ system allows for a practical, quick speed change even during the normal hose rewind with water under pressure, thus immediately reducing the turbine rotational speed without having to act on the electronic programmer controls.

RM Turbo-Reducer Unit does not require any periodic maintenance. Moreover, at the end of sprinkling process every liquid residue is automatically ejected from the turbine body.

AN EXTRAORDINARY ANCHORING

through the monolithic RM frames - flexible but indeformable



The Gx range of RM hose-reel irrigation machines features a swivelling turret structure, which, by rotating on the fixed bottom frame, allows the reel to be steered towards the desired direction to unwind the hose.

The machine is outfitted with duly oversized telescopic brackets to allow a high anchoring on any kind of ground. They are operated by self-balancing hydraulic cylinders with safety valves, and they ensure the required stability.

The transverse width of the highest reel allows to considerably lower the overall height of RM machines and their barycentre, thus making them among the stablest ones on the market. Starting from the 790Gx model the machine can be equipped with (optional) the rear unwinding arm of PE hose, by fastening the sprinkler trolley to the ground and towing the irrigation machine. This solution allows unwinding the hose by cancelling the friction on the ground, and exploiting the tracks already present in crops.

The 890Gx, 990Gx and 1100Gx models feature a great clear span of the frame with reference to the ground, thus preventing the underlying crops from being damaged during the hose unwinding.

Monolithic RM frames are free from any screwed structural elements, manufactured in a single block and hot-dip galvanized, designed through a three-dimensional calculation system.

ACCURACY IN ROTATION

by means of chain drive



Another remarkable characteristic of RM hose-reel irrigation machines: starting from the 581 Gx Evo model the **drive between turbo-reducer and reel is manufactured with high-tensile strength ARNOLD STOLZEMBERG®** chain with extruded rollers and without extension.

Moreover, by using the adjustable toothing (another exclusive of RM) located in the outer reel diameter, a very high transmission gear ratio is **created between the wheel and turbo-reduction gear in order to drastically reduce the energy absorption** for rewind as well as the turning moment in the reduction gear output shaft, thus preserving its duration in time; all models are outfitted with chain tightener with double idle gear (fixed+movable) with spring coupling to protect the whole structure in case of excessive strain during rewinding

In the 1100 Gx and 1200 Fx models drive chains are located on both reel sides in order to also cancel the torque effect of reel.

REEL AXLE:

the best technology available in the market



Reel mass with its hose in polyethylene wound and filled with water reaches 80% of machine weight.

Supports on which reel rotates are subject to very high loads, thus generating high frictions, which must be minimized in order to reduce the effort required for the movement.

Already starting from the 540 Gx model RM reel axle is:

1. Supported by large diameter **rolling-element bearings** that cancel frictions (1);
2. Protected by an **interchangeable stainless steel compass** (2) on which lip seals operate, thus ensuring that it lasts long even in the presence of aggressive fluids such as sludge.
3. Aided maintenance: when lip seals are worn out, they can be replaced in a few minutes.

This technology – an exclusive of all RM models – is applied to the whole range, including the cheapest models.

INTUITIVE OPERATION

by means of RM RainMaster 2.6 programmers



RM electronic programmers were designed to be perfectly built into the irrigation machine.

They are simply to use and feature an **intuitive, multilingual display**; it can be easily bypassed without interrupting the machine irrigation cycle in order to switch from automatic to manual operation.

Electromechanical drain and/or shut-off valves, GSM modem, solar panel for battery and anemometer recharge are available as optionals. The optional additional gun of rewind end can be controlled as well.

AN EXCEPTIONAL GRIP

by means of height-adjustable towing hitch eye



A partire dal modello 690 Gx Evo il timone è dotato dell'occhione di traino regolabile in altezza e attraverso semplici spinotti.



MULTI-SECTION TECHNOLOGY for an indestructible reel structure

Starting from the 581Gx model the reel resorts to the multi-section ribbed technology **fitted with sides completely made up of high strength DOMEX 420™** sheet with yield load to 420 kg/mm², made up of wedges precut by means of HD Laser system and then assembled through robotic welding. This leads to a high resistance to bending stress, despite the reel lightness, and to an increase by 300% of the PE hose supporting surface on reel sides - a remarkable advantage compared to the outdated system of side tubular tires. **The internal ferrule is made up of calendered flat sheet**, which helps preserve, then extend the duration of the polyethylene hose in the course of time.

The 890 Gx , 990 Gx models feature the "tapering profile" side reel section, so that all side bends can be effectively counteracted even during the most difficult rewinds.

Sections of each side were designed to be fully and thoroughly coated by the double-layer painting treatment even in the most internal parts. In that way steel does not deteriorate in the boxed or hidden parts. A side white segment allows checking the regular reel rotation even from a great distance.

MAXIMUM STABILITY AND DIRECTIONALITY UNDER ANY CONDITION

by means of RM rain gun trolleys



All the trolleys are available in the two- or four- fixed tyred wheel version and a steering pneumatics. This wheel allows the trolley to follow the irrigation hose in the position where it was unwound (fig. A), as being steering it is steered by the PE hose itself, thus eliminating the typical inaccuracy of the fixed middle wheel or slide trolleys that are not included in the ideal trajectory during the paths not perfectly straight (fig. B).

Cast iron wheels with directional crests – expressly designed to be paired with the steering wheel – are supplied as optional. They increase the steering and mass in the point where they are most required.

Both wheels are fitted with hubs with tapering bearings and lubricator.

The whole trolley structure is **hot-dipped galvanized**, thus ensuring an outstanding lifespan against corrosion.

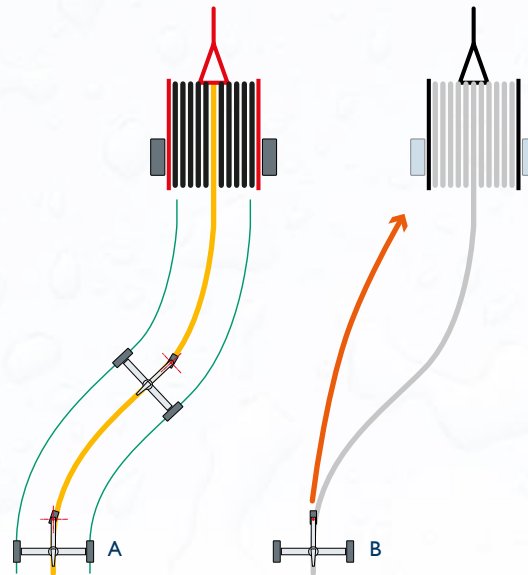

Customizable HYDRAULIC SYSTEM



Starting from the 570Gx Evo model, models are fitted with a complete hydraulic system for operating the rear hydraulic brackets and lifting the trolley. The hydraulic system can be implemented by means of hydraulic bar base, hydraulic rotation of turret, independent hydraulic lift of trolley (in the case of machines fitted with spraying boom) in all models. In the irrigation machines outfitted with rear unwinding arm of PE hose a specific tilting bar supporting base suitably structured is used: it is useful for improving the anchoring to the ground during rewind.

The following parts are available as optionals in place of the hydraulic tractor hose couple:

- Battery-powered hydraulic control unit with solar panels recharge.
- Hydraulic control unit controlled by 4-time engine unit with self-winding or electric start.

HIGHER RESISTANCE TO AGING

thanks to RM painting cycle

A preventive pickling treatment is performed on the painted parts of all RM machines as well as a following painting process through a double-layer **electrostatic system** – which ensures a coating even in the most hidden machine parts – **with highly eco-friendly water-based paints and primer**. Each cycle is accompanied by an in-oven stabilization treatment at 60°C, thus obtaining surfaces which are highly resistant to corrosion and especially to UV rays.

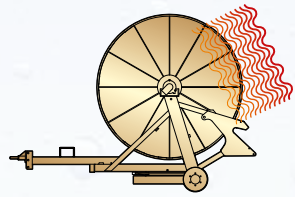

Drying in oven at 60°C

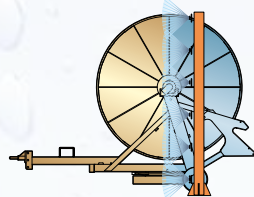

Bottom application

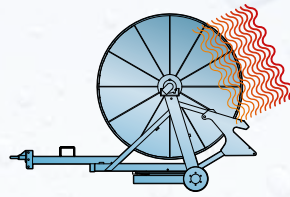

Drying in oven at 60°C

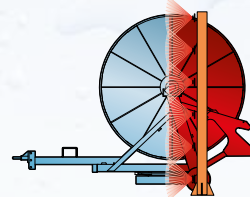

Two coats of paint

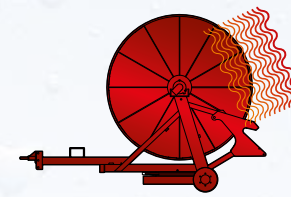

Drying in oven at 60°C

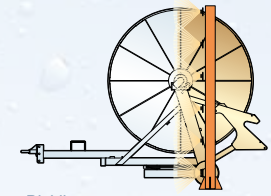

Pickling treatment

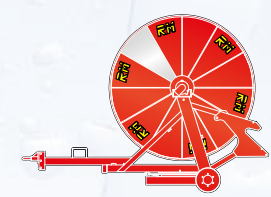

Decoration

DISTRIBUTION ALWAYS PERFECT

even at the end of rewind

Starting from the 540 Gx model the rain gun trolley stops on the ground at the end of rewind, and the following hooking and lift are carried out in fully automatic mode, that is, without any minimal interventions by the operator. All rain gun trolleys are fitted with the tilting hose terminal in order to avoid any changes in the trim when trolley comes close to the irrigation machine, thus maintaining the correct gun position until the end of the irrigation.

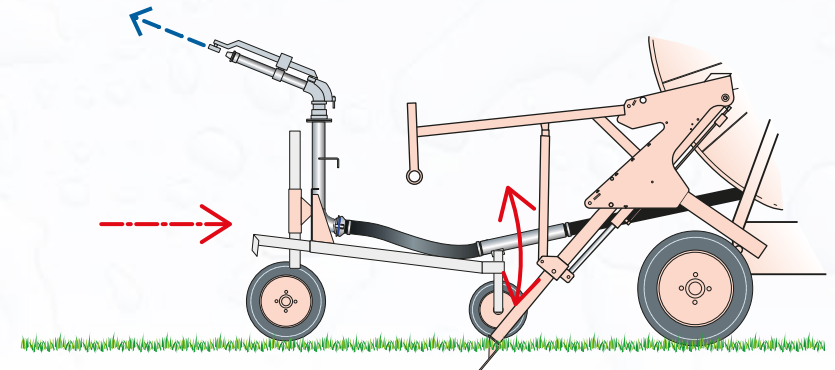
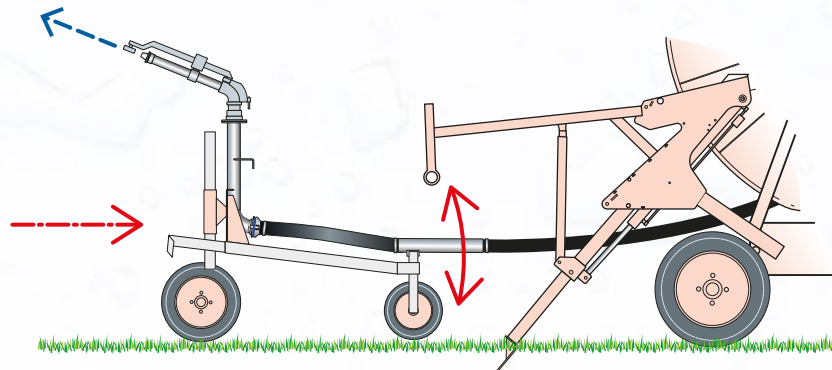
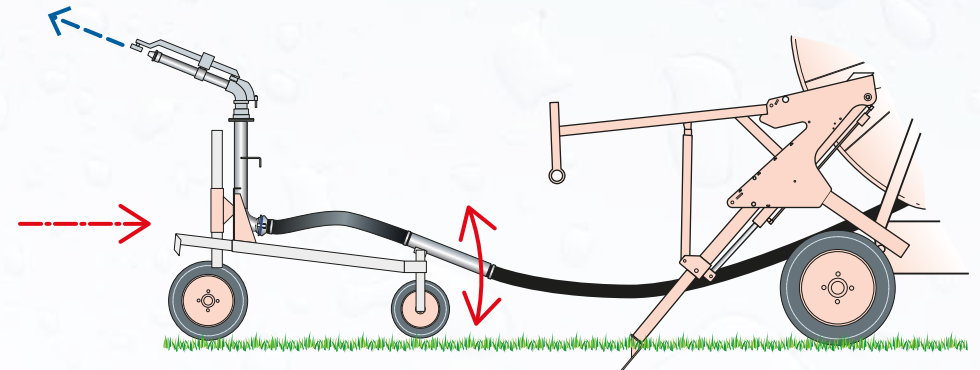

DOUBLE AXLE WITH ASYMMETRICAL ROCKER ARM less effort on towing on every kind of ground



All the models of the 990Gx and 1100Gx series – and as optionals in the 690Gx, 790Gx, 890Gx – are fitted with double axle with isodiametric wheels feature the asymmetrical rocker arm. This solution allows for a remarkable reduction in towing on rough soils, which – accompanied by a reduced side overall dimensions – also ensures a better distribution of weight during the steering phase, thus making the machine handier than the axle. Machines can be outfitted with different sizes of tyres like the “Big Size” type ones.

Very high-quality POLYETHYLENE HOSE with differentiated thickness

All RM hose-reel irrigation machines feature the medium density polyethylene hose (PEMD) with differentiated thickness starting from \varnothing 90 included; the highest thickness near the reel allows for a better accuracy on rewind and a less ovalisation due to hose bending.

GUARANTEE OF RELIABILITY, as machines are tested one by one.



All RM machines are thoroughly tested before being shipped to the customer. They undergo both mechanical tests – to check their operation – and hydraulic tests by means of pressure water at 12 bar to check the accuracy of joints and connections and the resistance of various components to water pressure.

ATTENTION PAID TO THE ENVIRONMENT by means of state-of-the-art technologies



RM manufactures its machinery and equipment in compliance with the environmental protection. They use raw materials coming from eco-friendly, certified cycles; they use exclusively water-based paints; they implement technologies in order to reduce energy consumptions. Those are some of the principles determining the technical choices for RM hose-reel irrigation machines, believing that only an attentive approach to those themes – aimed at reducing pollutant emissions – makes the external environment cleaner and the work healthier for workers.

ALL THAT FOR OUR RESULT



540 gx



External hose diameter	mm	50	63
Recommended hose length	m	250	190
Available max. length	m	250	190
Flow rate delivered	m ³ /h	6,4÷16	10÷21
Recommended nozzle	ø mm	10÷14	12÷16

560 gx



External hose diameter	mm	63	70	75	82
Recommended hose length	m	300	330	250	160
Available max. length	m	340	330	250	160
Flow rate delivered	m ³ /h	10+21	12+26	14+34	16+37
Recommended nozzle	ø mm	12+16	14+18	14+20	16+22

570 gx EVO



External hose diameter	mm	75	82	90	100
Recommended hose length	m	350	320	270	200
Available max. length	m	360	330	310	220
Flow rate delivered	m ³ /h	14+26	19+48	25+52	26+60
Recommended nozzle	ø mm	14+18	16+24	18+28	20+28



581 gX EVO



External hose diameter	mm	82	90	100	110
Recommended hose length	m	400	370	320	250
Available max. length	m	430	400	350	270
Flow rate delivered	m ³ /h	19-42	25-52	26-68	26-68
Recommended nozzle	ø mm	16+22	18+28	20+30	20+32

690 gX EVO



External hose diameter	mm	90	100	110	120	125
Recommended hose length	m	450	400	350	270	250
Available max. length	m	520	470	380	320	300
Flow rate delivered	m ³ /h	25+52	26+77	29+80	37+100	44+110
Recommended nozzle	ø mm	18+28	20+28	22+32	24+36	24+36

790 gx



External hose diameter	mm	100	110	120	125
Recommended hose length	m	470	450	350	330
Available max. length	m	500	490	370	350
Flow rate delivered	m ³ /h	26+68	29+78	37+100	44+110
Recommended nozzle	ø mm	20+28	22+30	24+34	24+36

890 gx



External hose diameter	mm	100	110	120	125	135	140	150
Recommended hose length	m	550	550	420	400	380	270	260
Available max. length	m	600	570	440	420	390	300	280
Flow rate delivered	m ³ /h	26÷68	29÷86	40÷140	44÷140	44÷175	44÷180	44÷190
Recommended nozzle	ø mm	20÷28	22÷28	24÷34	24÷38	24÷40	24÷40	24÷42



890 gx EVO



External hose diameter	mm	100	110	120	125	135	140	150
Recommended hose length	m	600	550	500	480	450	360	330
Available max. length	m	680	600	540	520	470	390	360
Flow rate delivered	m ³ /h	26+55	29+60	44+110	44+140	44+163	44+175	44+190
Recommended nozzle	ø mm	20+26	22+30	24+34	24+38	24+40	24+40	26+42

990 gx



External hose diameter	mm	110	120	125	135	140	150
Recommended hose length	m	650	580	550	500	450	380
Available max. length	m	700	600	580	550	520	400
Flow rate delivered	m ³ /h	29+60	29+90	44+130	44+145	52+163	52+163
Recommended nozzle	ø mm	22+28	24+34	24+36	24+38	26+40	26+42

1100 gx



External hose diameter	mm	110	120	125	135	140
Recommended hose length	m	730	700	670	570	550
Available max. length	m	760	730	700	600	580
Flow rate delivered	m ³ /h	29÷90	40÷130	44÷140	44÷160	52÷175
Recommended nozzle	ø mm	20÷28	24÷34	24÷36	24÷40	26÷42

900 FX



External hose diameter	mm	110	120	125	135	140	150	160
Recommended hose length	m	650	580	550	500	480	380	360
Available max. length	m	700	600	580	550	520	400	380
Flow rate delivered	m ³ /h	29÷70	29÷96	44÷130	44÷145	52÷163	52÷163	55÷170
Recommended nozzle	ø mm	22÷28	22÷32	24÷36	24÷38	26÷40	26÷42	26÷42

1200 FX



External hose diameter	mm	125	135	140	150
Recommended hose length	m	850	700	670	600
Available max. length	m	900	730	700	660
Flow rate delivered	m ³ /h	18÷70	44÷160	52÷175	50÷180
Recommended nozzle	ø mm	20÷28	24÷40	26÷42	26÷44

OVERALL DIMENSIONS AND WEIGHTS

Values are merely indicative, and they can vary according to technical outfitting or technological upgrades.

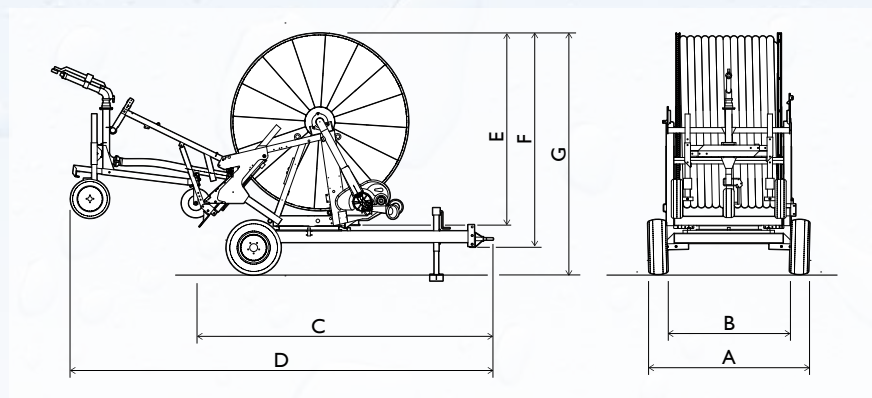

540 gx

A	B	C	D	E	F	G	KG
1480*	1200	2240	3650	1400*	1560	1850	650**

* minimum measures for transport
** (ø 63/190 mm)

690 gx EVO

A	B	C	D	E	F	G	KG
2390*	2150	3440	5300	2700*	2980	3320	2850**

* minimum measures for transport
** (ø 100/400 mm)

990 gx

A	B	C	D	E	F	G	KG
2550*	2470	4400	7200	3450*	3700	4320	6300**

* minimum measures for transport
** (ø 125/550 mm)

560 gx

A	B	C	D	E	F	G	KG
1780*	1630	2850	4550	1820*	2020	2340	1140**

* minimum measures for transport
** (ø 75/250 mm)

790 gx

A	B	C	D	E	F	G	KG
2500*	2270	3790	5740	2670*	3000	3340	3430**

* minimum measures for transport
** (ø 110/400 mm)

1100 gx

A	B	C	D	E	F	G	KG
2800*	2200	4400	7200	3800*	4050	4620	7150**

* minimum measures for transport
** (ø 125/600 mm)

570 gx EVO

A	B	C	D	E	F	G	KG
2100*	1900	3210	5000	2070*	2320	2670	1680**

* minimum measures for transport
** (ø 82/300 mm)

890 gx

A	B	C	D	E	F	G	KG
2550*	2350	3940	6730	3100*	3440	3820	3900**

* minimum measures for transport
** (ø 125/400 mm)

900 FX

A	B	C	D	E	F	G	KG
2680*	2080	4800	7000	3500*	3580	3950	6680**

* minimum measures for transport
** (ø 125/550 mm)

581 gx EVO

A	B	C	D	E	F	G	KG
2320*	2150	3170	5460	2300*	2620	2950	2200**

* minimum measures for transport
** (ø 90/350 mm)

890 gx EVO

A	B	C	D	E	F	G	KG
2550*	2350	3940	6730	3340*	3670	4060	4150**

* minimum measures for transport
** (ø 125/450 mm)

1200 FX

A	B	C	D	E	F	G	KG
2960*	2470	4000	7800	4000*	4450	4800	10800**

* minimum measures for transport
** (ø 150/530 mm)

CUSTOM-TAILORING

Besides the wide selection of models, a complete range of optional extras are available to suit each customers' needs.

A shortlist of interesting possibilities manufactured to the highest levels of quality in order to adapt RM self-propelled irrigator to your specific expectations.





Trolley with three pneumatic wheels (standard) on all the Gx models.



Trolley with single cast iron wheels (optional starting from the 570 Gx Evo model).



Under-foliage sprinkler device for tall tree.



Device for automatic reversal of rotation of gun locks (for SIME guns only).



Trolley with two pneumatic wheels and two cast iron wheels.



Four-pneumatic wheel trolley



Independent trolley lifting controlled by a couple of hydraulic cylinders (mandatory with spraying boom) for the following models: 581 Gx, 690 Gx, 790 Gx, 890 Gx, 990 Gx e 1100 Gx.



Device for locking trolley to the ground with pickaxe (for models with rear hose unwinding).



Arm for rear hose unwinding (optional for the 790 Gx, 890 Gx, 990 Gx, 1100 Gx models) and standard on the 1200 Fx.



Stretched angle K1 additional rain gun mounted on trolley.



Under-foliage sprinkler device for orchards/vineyards in place of standard trolley.



Kit for side unwind trolley.



Hose rewind through YANMAR LD70 diesel engine complete with hydrostatic transmission with hydraulic motor on the reduction gear; speed compensating valve, double hydraulic pump for service feed; it can be paired with RM electronic programmers. The optional replaces the turbine rewinding.



ECU operated by 4-stroke HONDA GX160 engine Hp 5.5 for hydraulic services.



Flanged litre-counter on reel inlet.



Additional coupler for sludge inlet and turbine cutting off.



PE hose rewind through hydraulic motor on PTO, speed adjusting valve, limit switch spool valve and quick coupling torque to tractor.



Water pilot operated drain valve.

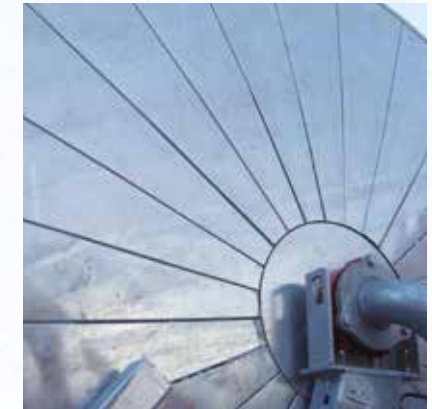

Hot-dip galvanizing treatment on reel.



Compressor for emptying the hose JUROP 9000 lt.



ProgramRain 10-12 – Nortoft programmer.



Solar panel for powering electronic equipment.



Manual pump for operating rear brackets and lifting trolley (optional for the 570 Gx Evo, 581 Gx Evo, 690 Gx, 790 Gx models).



Signal of hose rewind end with xenon arc lamp for RM programmer.



RM programmer, RainMaster 2.6 model (with antenna and in-built optional GSM module).



Electromechanical drain valve and electromechanical shut-off valve controlled by programmer (supplied separate or paired and controlled by electric switch).



Anemometer for RAINMASTER 2.6.



Rain Speed 60 digital metre counter for measuring the rewinding speed.



Amplified antenna for GSM module.



Protection stainless steel box for RainMaster 2.6 programmer.



Additional limit switch rain gun controlled by programmer (Skipper or KI model).



Hydraulic rotation of fifth wheel (standard on all the 990 Gx, 1100 Gx models; optional for all the other models).



Transparent painting for boosting the protection of galvanized parts.



Hydraulic tilting rudder foot (optional for 790, 890, 990 and 1100 GX).



Double axle on asymmetrical rocker arm (optional for the 690 Gx, 790 Gx, 890 Gx, 890 Gx Evo models).



Water inlet on both sides (standard on all the Gx models starting from 581).



Inlet filter for B 76, 108 and 133 joint.



"Big size" type tyre for the 581 Gx Evo model size 26/12.00-12.



"Big size" type tyre for the 690 Gx Evo and 790 Gx models size 31x15.50-15.



"Big size" type tyre for the 890 Gx, 990 Gx models, standard on the 1100 Gx model (size 15.0/55-17).

LOW-PRESSURE SPRAYING BOOMS

OPTIONAL FOR ALL MODELS

72-metre Albatros boom with 3 wheel trolley (paired with 990 Gx e | 1100 Gx)





Steel boom with 30-metre structure



Steel boom with 30-metre structure



Steel boom with 50-metre structure assembled on the 890 Gx



Steel boom for distributing sludge from 28 metres with descent



Steel boom with 40-metre structure



Albatros boom with 72-metre structure (optional for the 990 Gx and 1100 Gx models).

MODEL	560 Gx		581 Gx Evo		790 Gx		890 Gx Evo		1100 Gx		1200 FX	
	540 Gx		570 Gx Evo		690 Gx Evo		890 Gx		990 Gx		900 Fx	
Flow-distributor turbine with built-in by-pass	•	•	•	•	•	•	•	•	•	•	•	•
4-speed gearbox with shafts completely in oil bath	!	•	•	•	•	•	•	•	•	•	•	•
PTO for fast hose rewinding	•	•	•	•	•	•	•	•	•	•	•	•
Braking system to unwind the hose with fully automatic operation	!	•	•	•	•	•	•	•	•	•	•	•
Automatic speed compensator according to the hose winding diameter	•	•	•	•	•	•	•	•	•	•	•	•
Anti-slackening hose safety device	•	•	•	•	•	•	•	•	•	•	•	•
Safety device to stop the machine if the hose winds unevenly	•	•	•	•	•	•	•	•	•	•	•	•
Electronic hose rewinding speed measuring device	•	•	•	•	•	•	•	•	•	•	•	•
Worm screw hose turning system with micrometric regulation and double guide	•	•	•	•	•	•	•	•	•	•	•	•
Reel support on ball bearings and lipped retention ring with stainless steel bushing	•	•	•	•	•	•	•	•	•	•	•	•
Frame swivelling on a ball bearing centre plate through 360°	•	•	•	•	•	•	•	•	•	•	!	!
Trolley lifting at the end of sprinkling by means of the manual crank (or manual hydraulic pump)	•	•	◊	◊	◊	◊	!	!	!	!	!	!
Self-balancing hydraulically controlled rear anchoring brackets, and hydraulic lift of trolley (automotion)	!	!	•	•	•	•	•	•	•	•	•	•
Bar base hydraulically controlled through spool valve	!	!	◊	◊	◊	◊	•	•	•	•	•	•
Flexible rubber hose to supply the machine, complete with connections	•	•	•	•	•	•	•	•	•	•	•	•
Two-wheeled cast iron sprinkler trolley	!	!	◊	◊	◊	◊	◊	◊	◊	◊	◊	◊
Four-wheel trolley (cast iron or pneumatic)	!	!	!	◊	◊	◊	◊	◊	◊	◊	◊	◊
Adjustable trolley track and wheel height	•	•	•	•	•	•	•	•	•	•	•	•
SIME sprinkler with slow return and set of nozzles	•	•	•	•	•	•	•	•	•	•	•	•
Pressure-gauge in glycerine bath on the machine	•	•	•	•	•	•	•	•	•	•	•	•
Pressure-gauge in glycerine bath on the sprinkler (SIME)	!	!	•	•	•	•	•	•	•	•	•	•
Ball joint on sprinkler trolley	!	•	!	•	•	•	•	•	•	•	•	•
Sprinkler trolley ballasts	!	•	•	•	•	•	•	•	•	•	•	•
Adjustable bar eye	!	!	!	•	•	•	•	•	•	•	•	•
Hose rewinding with single-cylinder diesel engine (without turbine)	!	!	!	!	◊	◊	◊	◊	◊	◊	◊	◊
Additional sludge inlet for turbine cutting off	◊	◊	◊	◊	◊	◊	◊	◊	◊	◊	◊	◊
Hot-dip galvanized structure (painted reel)	•	•	•	•	•	•	•	•	•	•	•	•
Hot-dip galvanized reel	!	◊	◊	◊	◊	◊	◊	◊	◊	◊	◊	!
Drain valve piloted by the fluid for vacuum stops	◊	◊	◊	◊	◊	◊	◊	◊	◊	◊	◊	◊
Stop valve for slow fluid piloted water inlet shut-off	◊	◊	◊	◊	◊	◊	◊	◊	◊	◊	◊	◊
Turbine inlet filter	!	◊	◊	◊	◊	◊	◊	◊	◊	◊	◊	◊
Hydraulic spool valve for services	!	!	◊	◊	◊	•	•	•	•	•	•	•
Hydraulic control unit for services with rechargeable battery through solar panels	!	!	◊	◊	◊	◊	◊	◊	◊	◊	◊	◊
Manually operated auxiliary sprinkler	!	!	◊	◊	◊	◊	◊	◊	◊	◊	◊	◊
Water inlet on both sides	!	!	◊	•	•	•	•	•	•	•	•	•
K1 auxiliary sprinkler controlled by Rainmaster 2.6 programmer	!	!	◊	◊	◊	◊	◊	◊	◊	◊	◊	◊
RIVER auxiliary sprinkler controlled by Rainmaster 2.6 programmer	!	!	!	!	◊	◊	◊	◊	◊	◊	◊	◊
Costant Rain 7 - Program Rain 10 – Nortoft programmer	◊	◊	◊	◊	◊	◊	◊	◊	◊	◊	◊	◊
GSM module for programmer	◊	◊	◊	◊	◊	◊	◊	◊	◊	◊	◊	◊
Rainmaster 2.6 programmer	◊	◊	◊	◊	◊	◊	◊	◊	◊	◊	◊	◊
Engine unit for hydraulic movements	!	!	!	◊	◊	◊	◊	◊	◊	◊	◊	◊
Hydraulic rotation of turret with additional of an element on the spool valve	!	!	◊	◊	◊	◊	◊	◊	•	•	!	!
Engine-driven pump unit built into the machine structure	!	!	!	!	!	◊	◊	◊	◊	◊	!	!
Vacuum pump to empty the hose	!	!	!	!	◊	◊	◊	◊	◊	◊	◊	◊
Double axle on rocker arm	!	!	!	!	◊	◊	◊	◊	•	•	!	!

A WIDE RANGE OF MODELS FOR EVERY NEED



..... OFFERING A WORLDWIDE ASSISTANCE

The presence: this is the most important characteristic of RM after the customer purchases the machine. Anywhere in the world. A constant vicinity to our customers. We will never abandon an RM hose-reel irrigation machine, it will always be looked after in an efficient and productive way. Therefore, maintaining its value over time.





www.rmirrigation.com

Via Provinciale, 41 - Loc. S. QUIRICO
43018 SISSA TRECASALI - (Parma) - ITALY
Tel. 0521 872 321 - Fax. 0521 874 027 International phone (+39) 0521 872 321
E-mail: info@rmirrigation.com



The models pictured in this leaflet may undergo some changes and be upgraded, thus changing their technical specifications.
Pictures may show outfits or optional accessories that are not an integral part of the equipment originally supplied.
Commercial RM network is always willing to provide you with all the most detailed, updated information.
"RM", "SuperRain", "Speedy Rain", "Albatros", "Falcon" logo are trademarks. © 2019 RM S.p.A. Printed in Italy.
Cod.: 203